

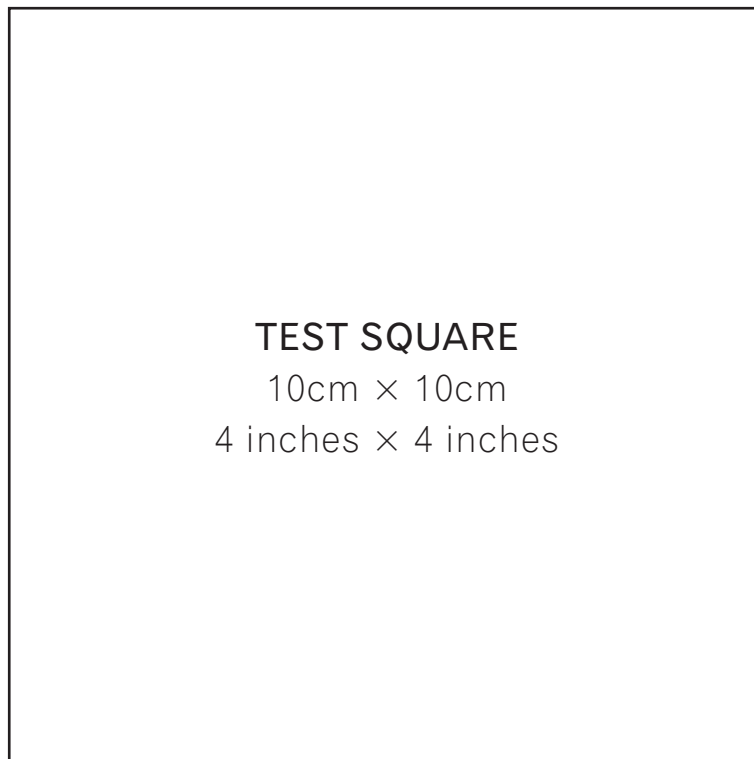

XS _____
S
M - - - - -
L _____
XL _____

Three-hour Slouchy Cardigan
Project design © Love Productions 2015
This design is protected by copyright and
must not be made for resale.



TEST SQUARE
10cm × 10cm
4 inches × 4 inches

1A

1B

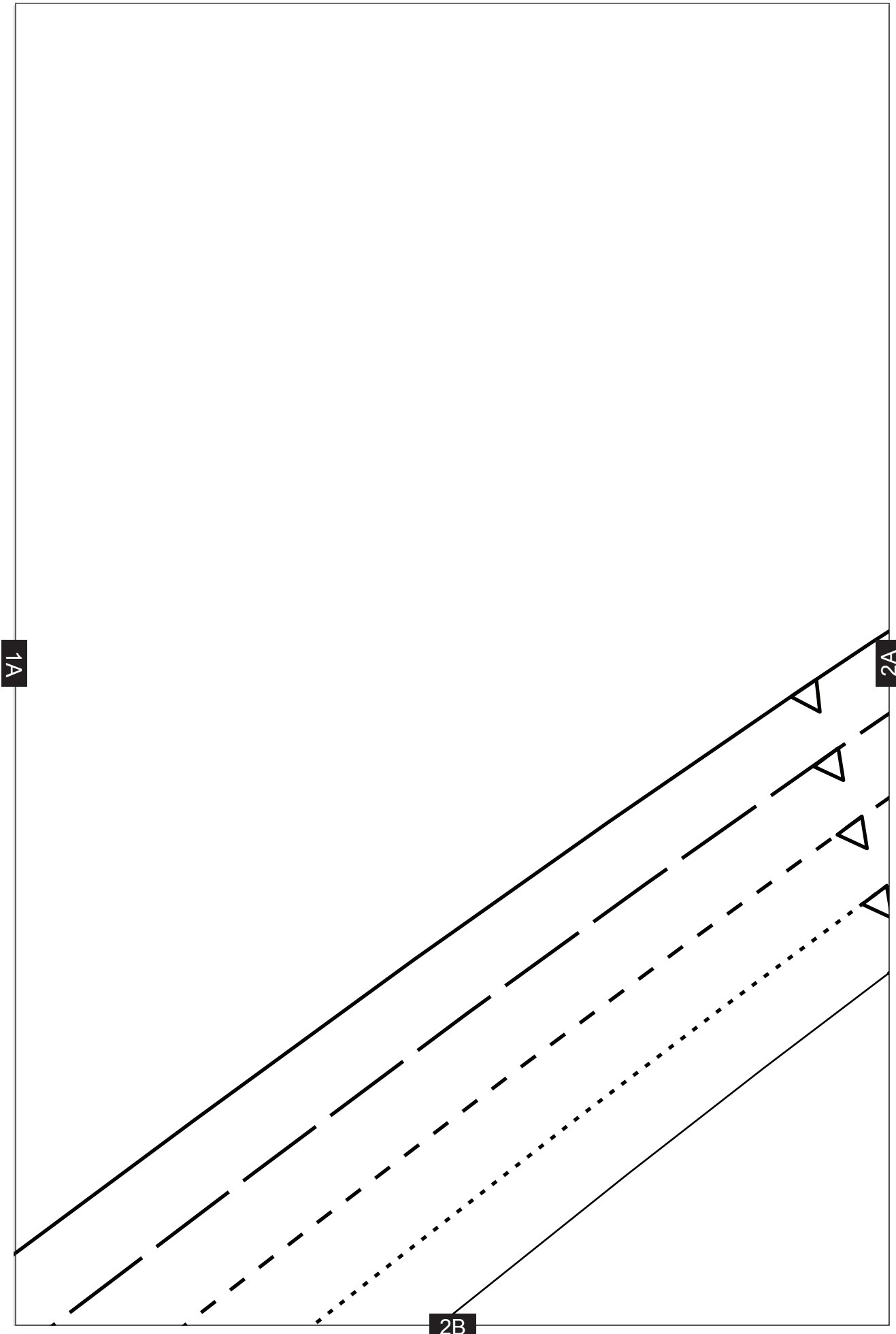

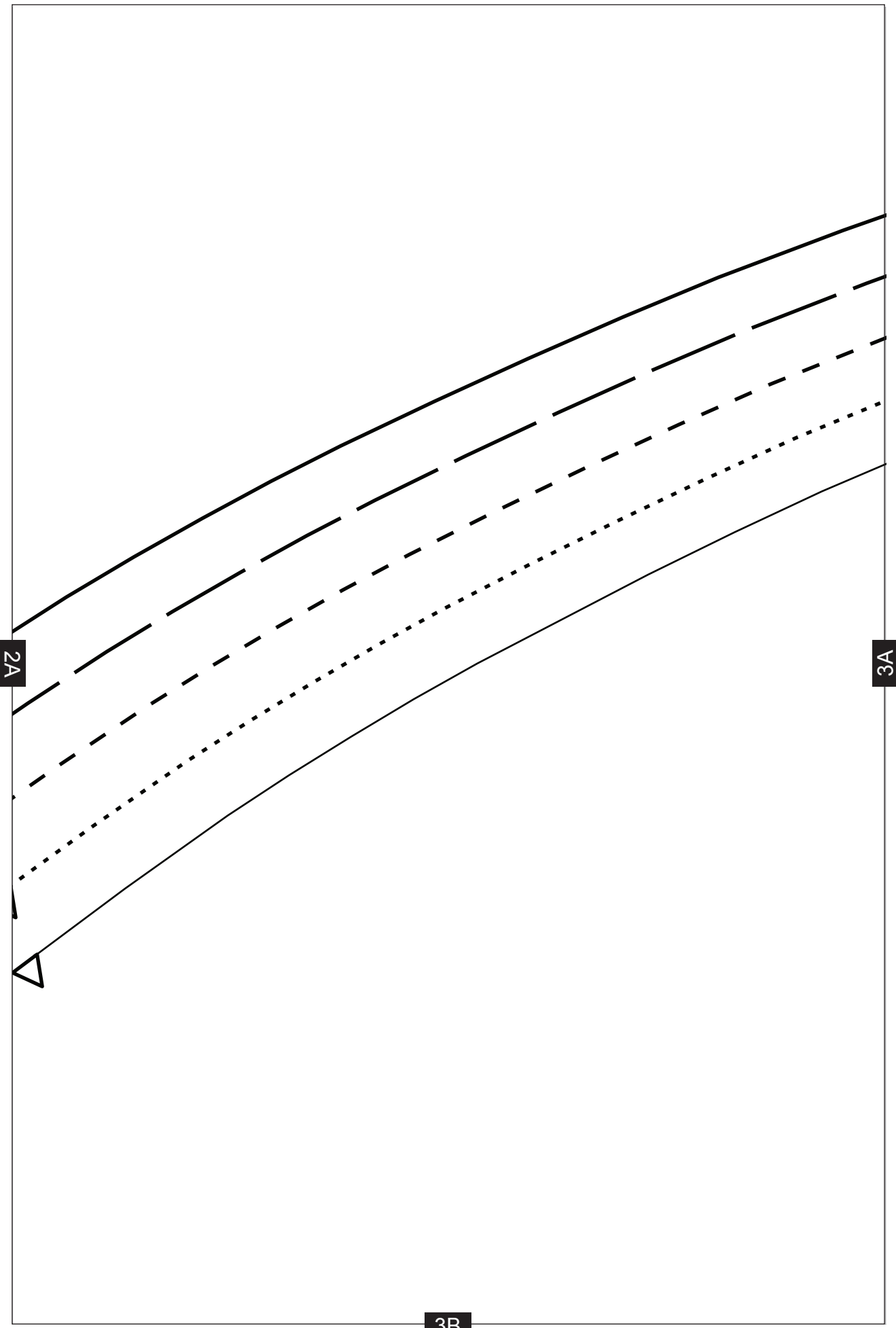

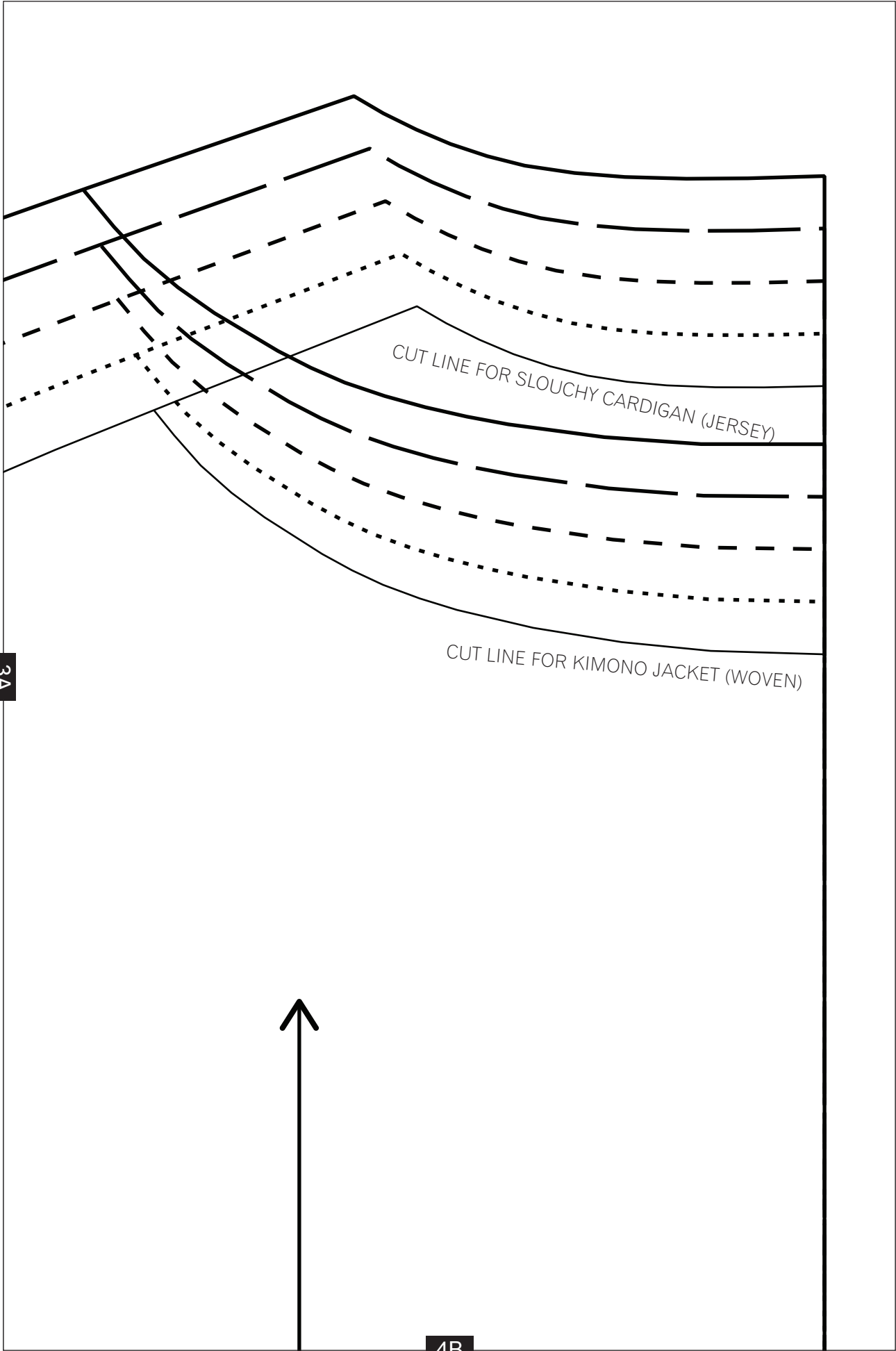

3A

4B

1B

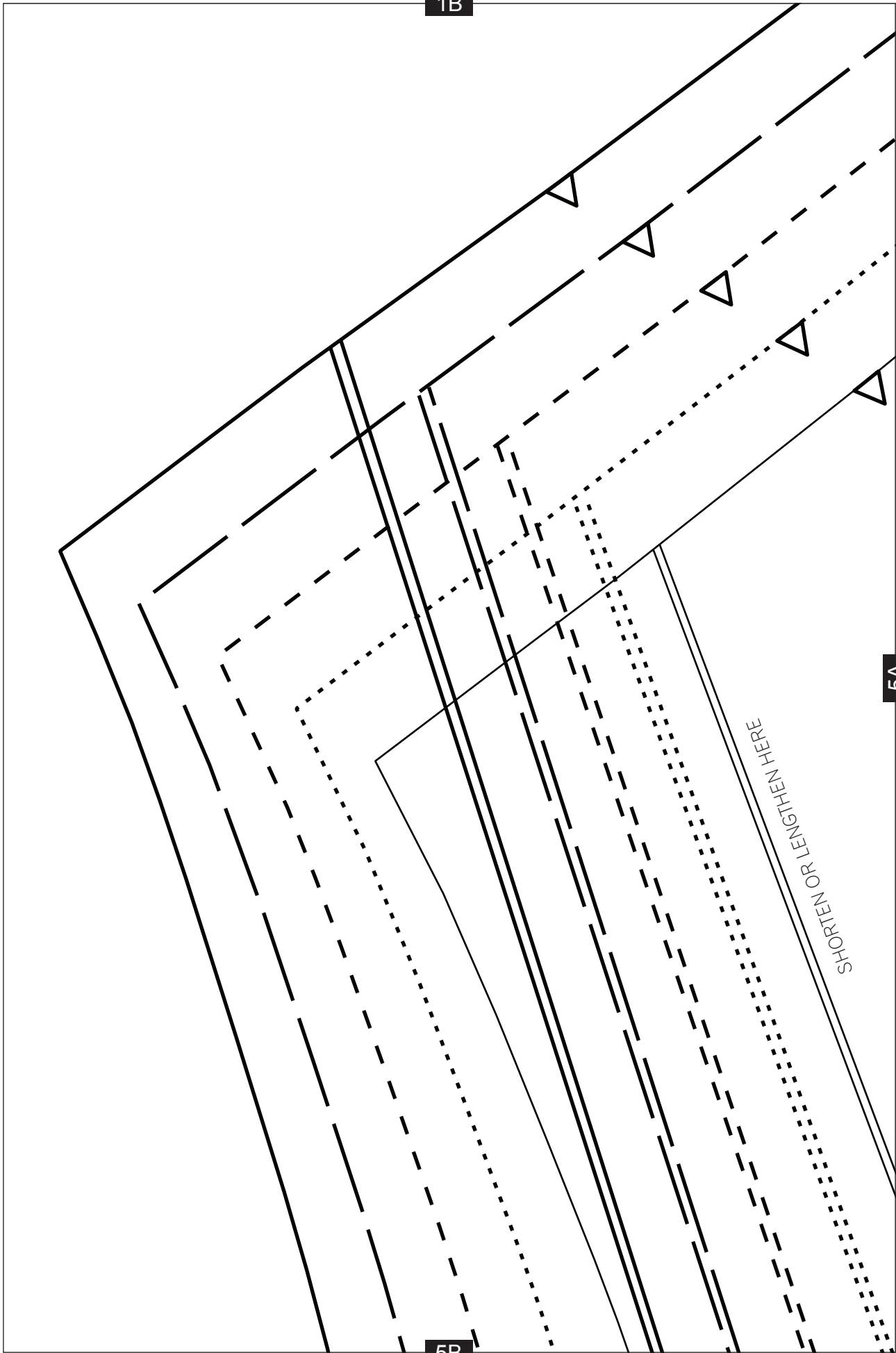

5A

SHORTEN OR LENGTHEN HERE

5B

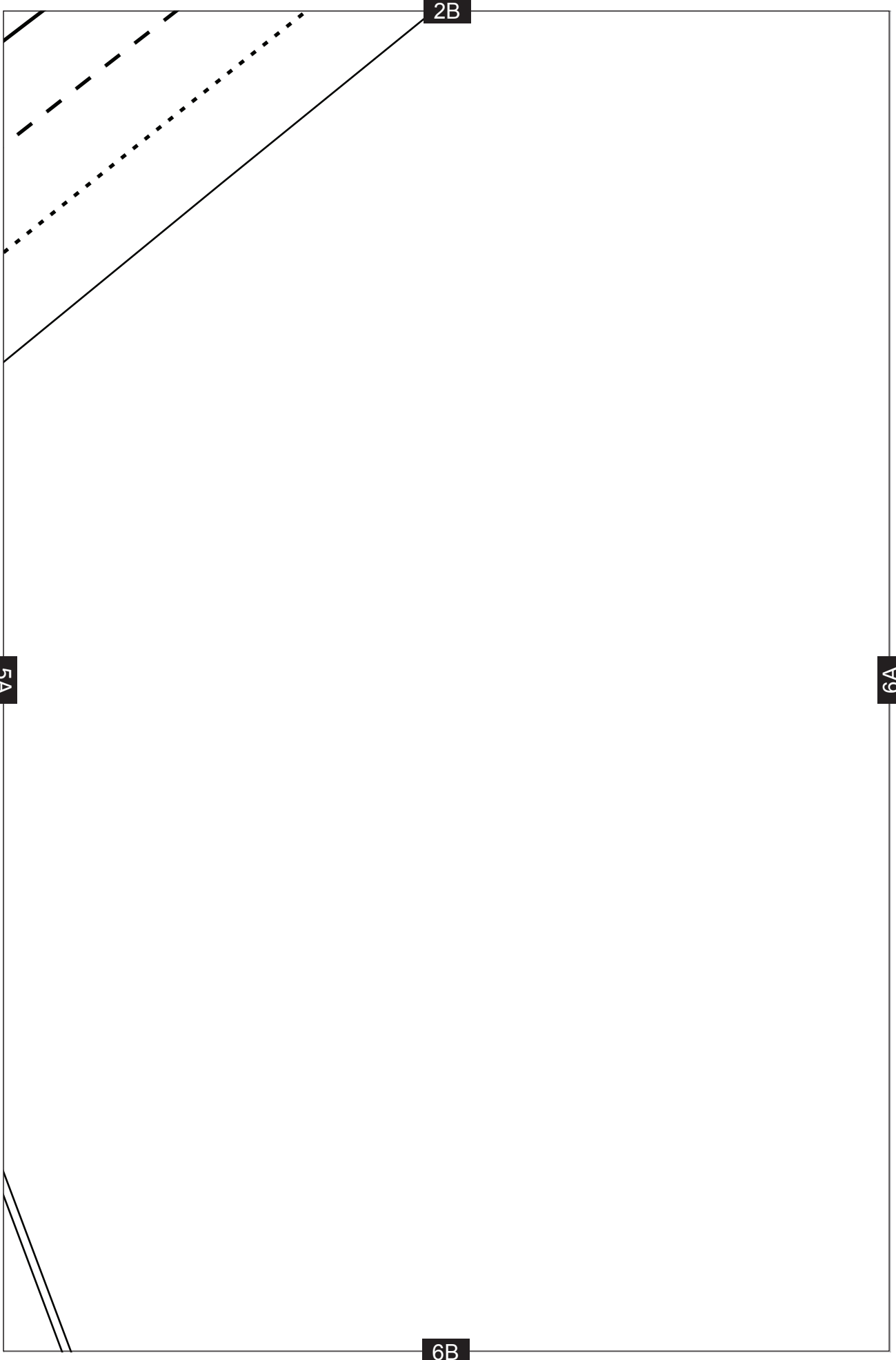

3B

THREE-HOUR SLOUCHY CARDIGAN
BACK – CUT ON FOLD

6A

7A

7B

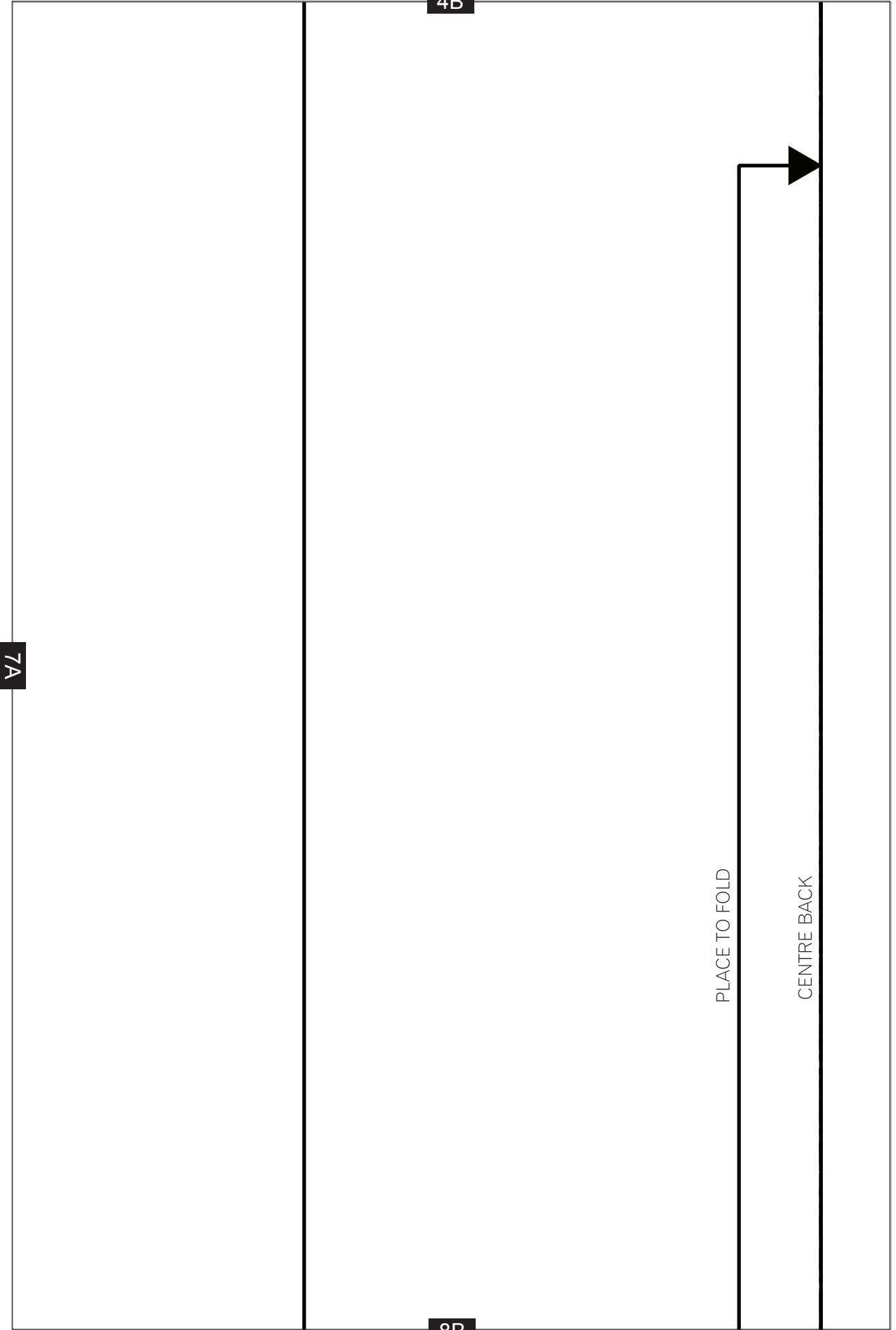

7A

4B

8B

PLACE TO FOLD

CENTRE BACK



5B

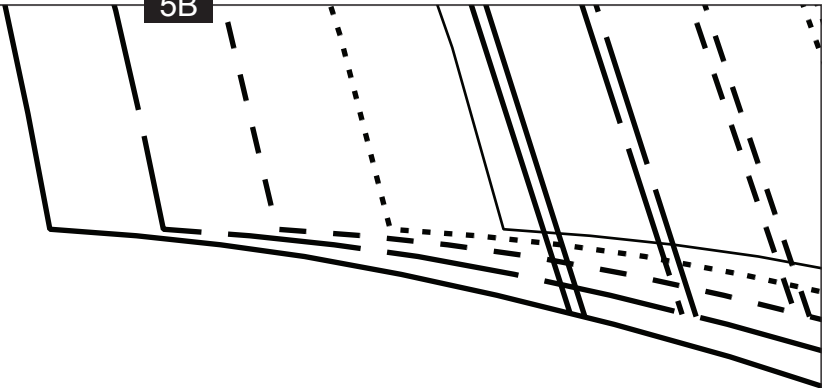

9A

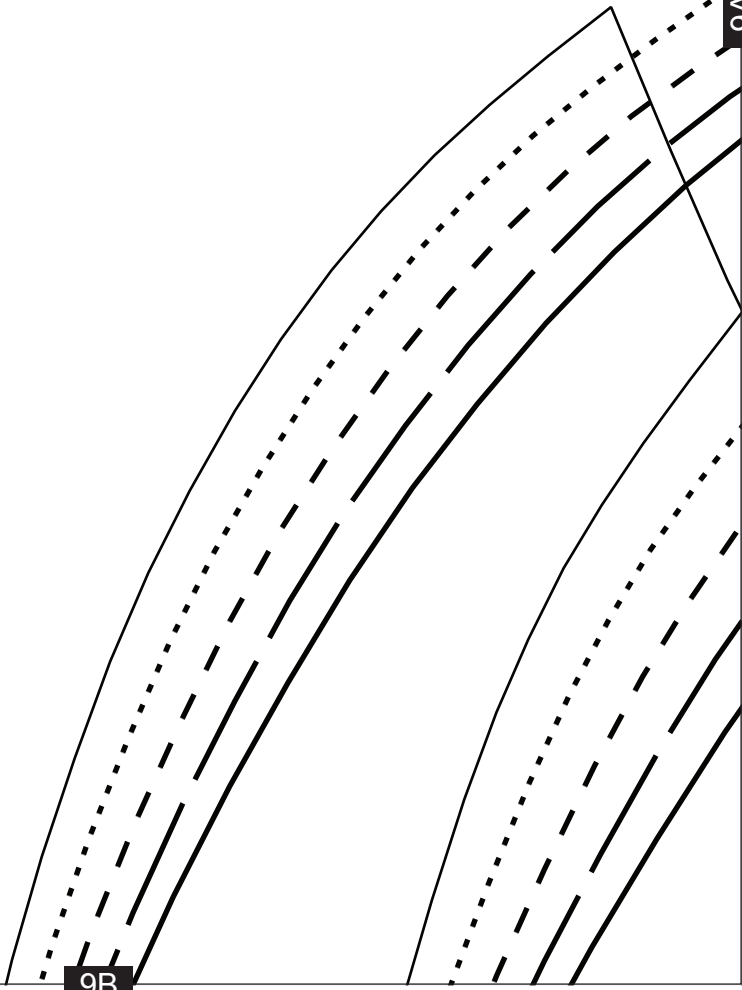

9B



6B

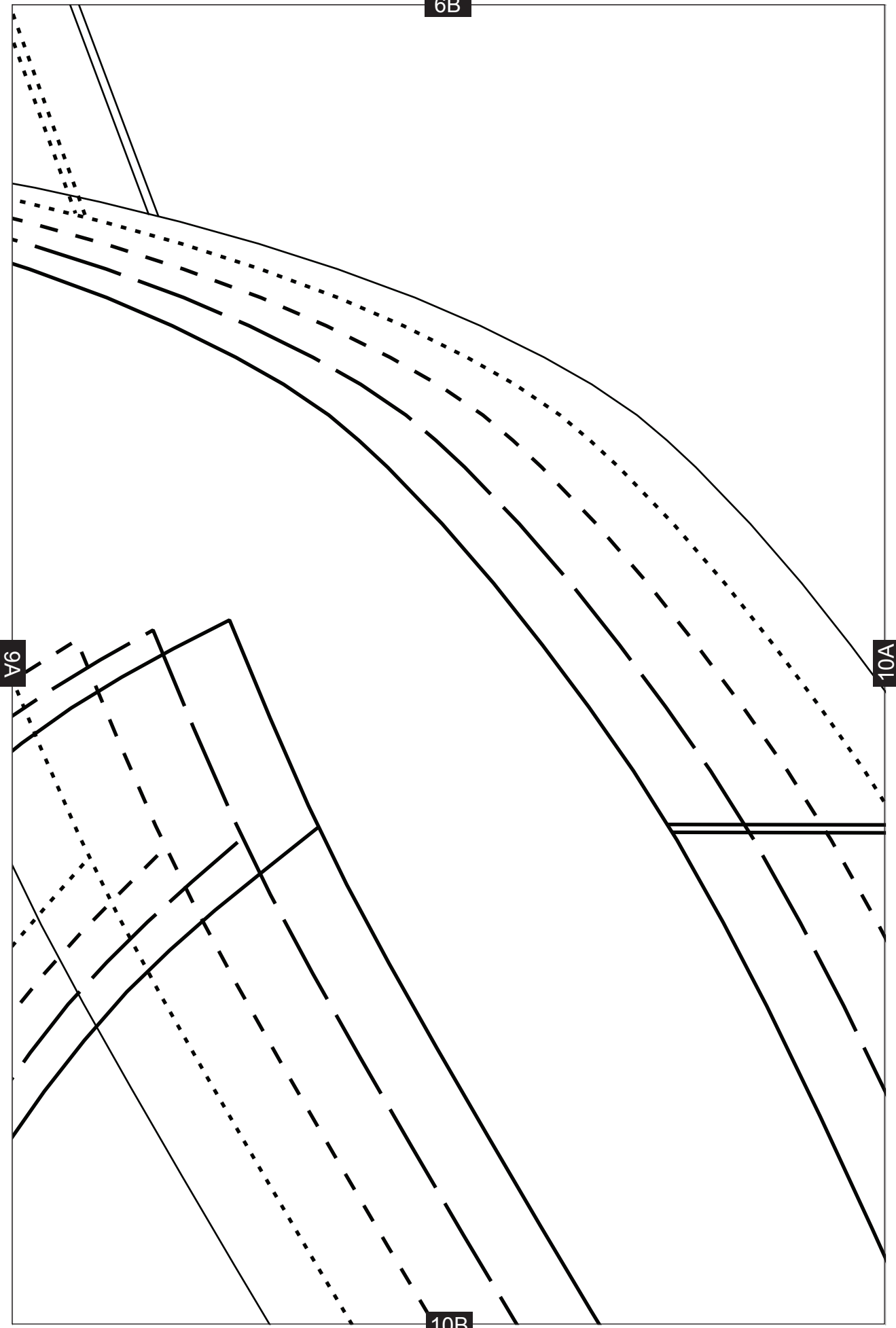

9A

10A

10B

7B

10A

11A

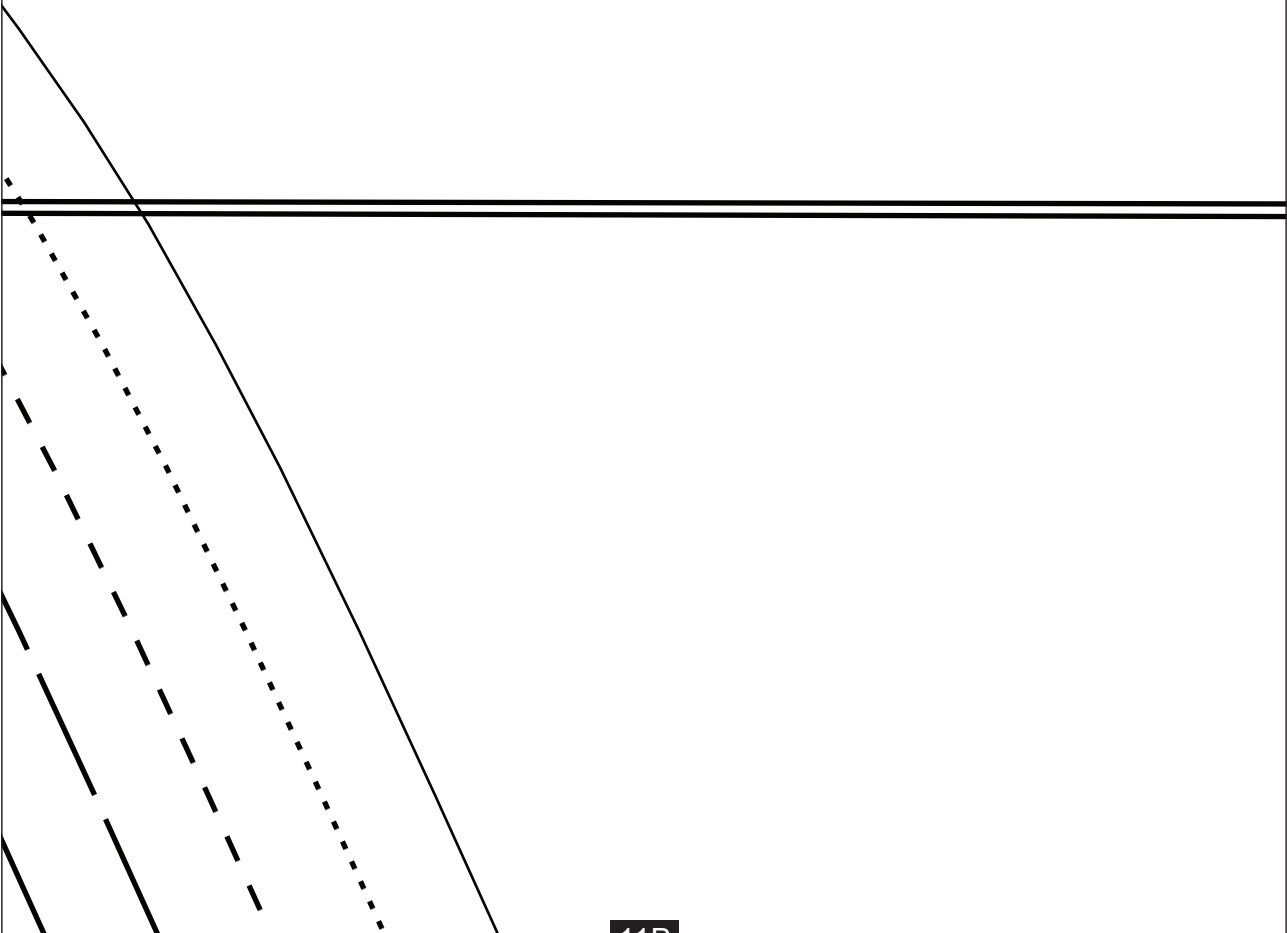

11B

8B

11A

SHORTEN OR LENGTHEN HERE

12B



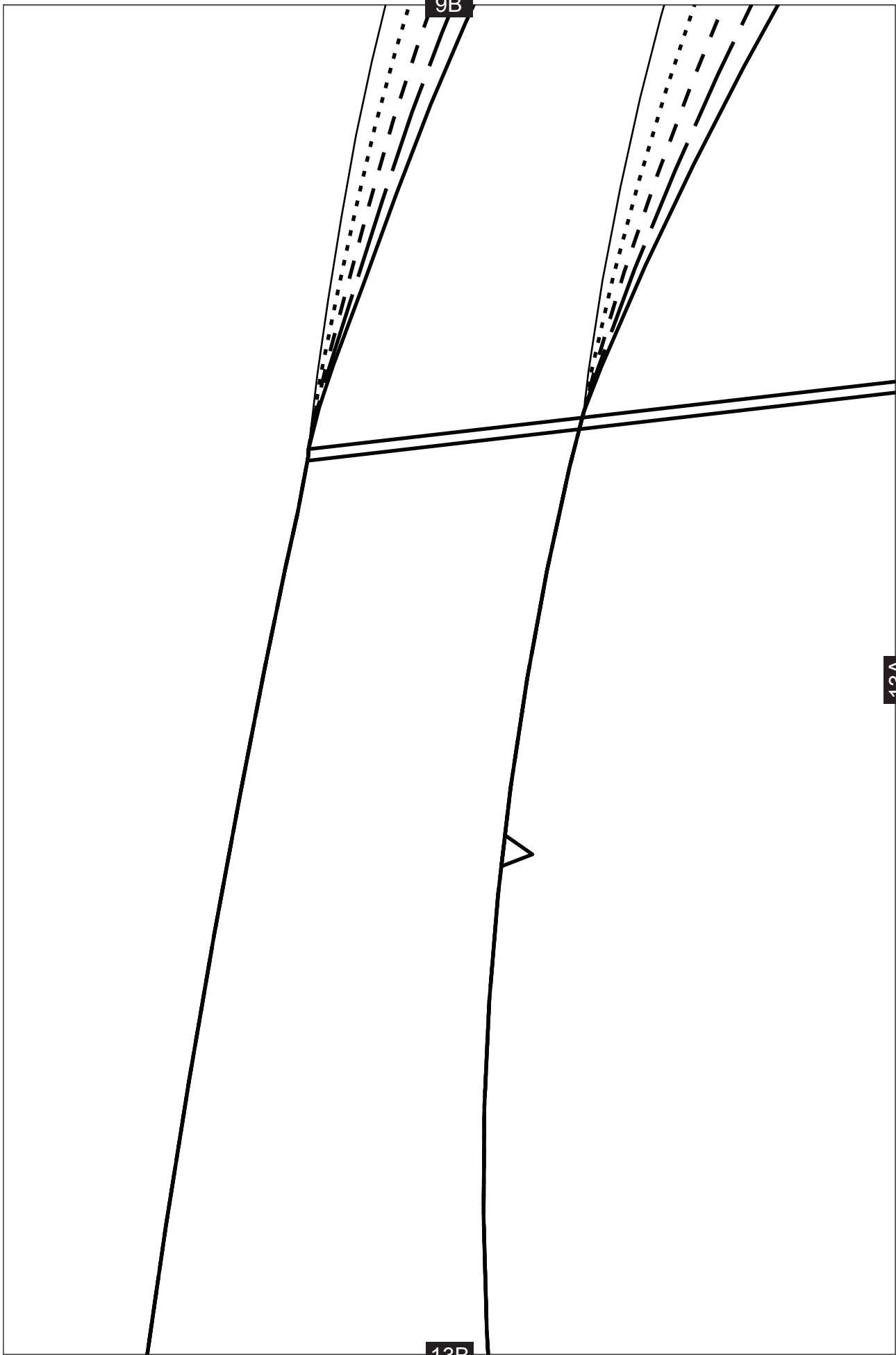

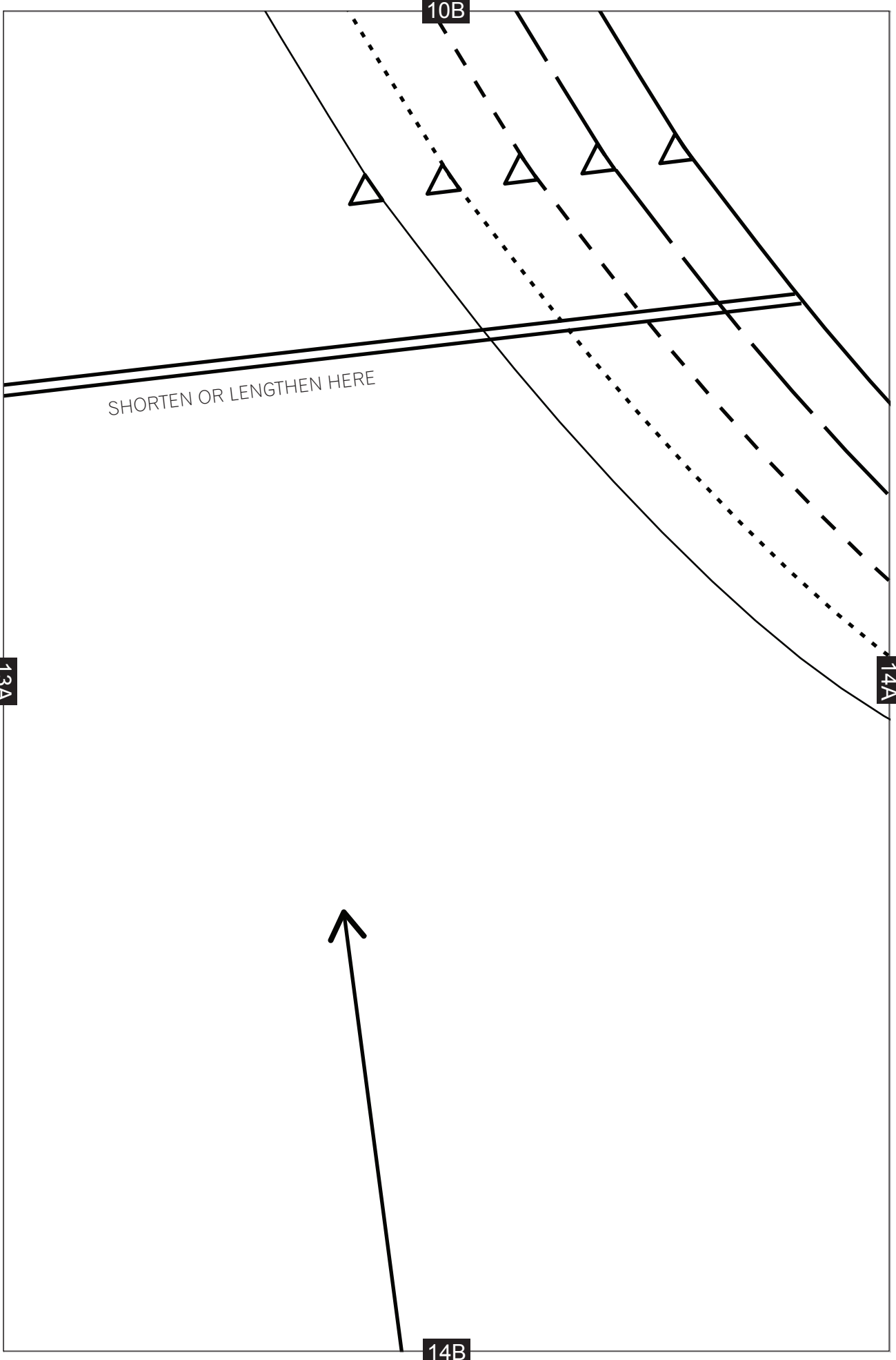

11B

14A

15A

15B

SHORTEN OR LENGTHEN HERE

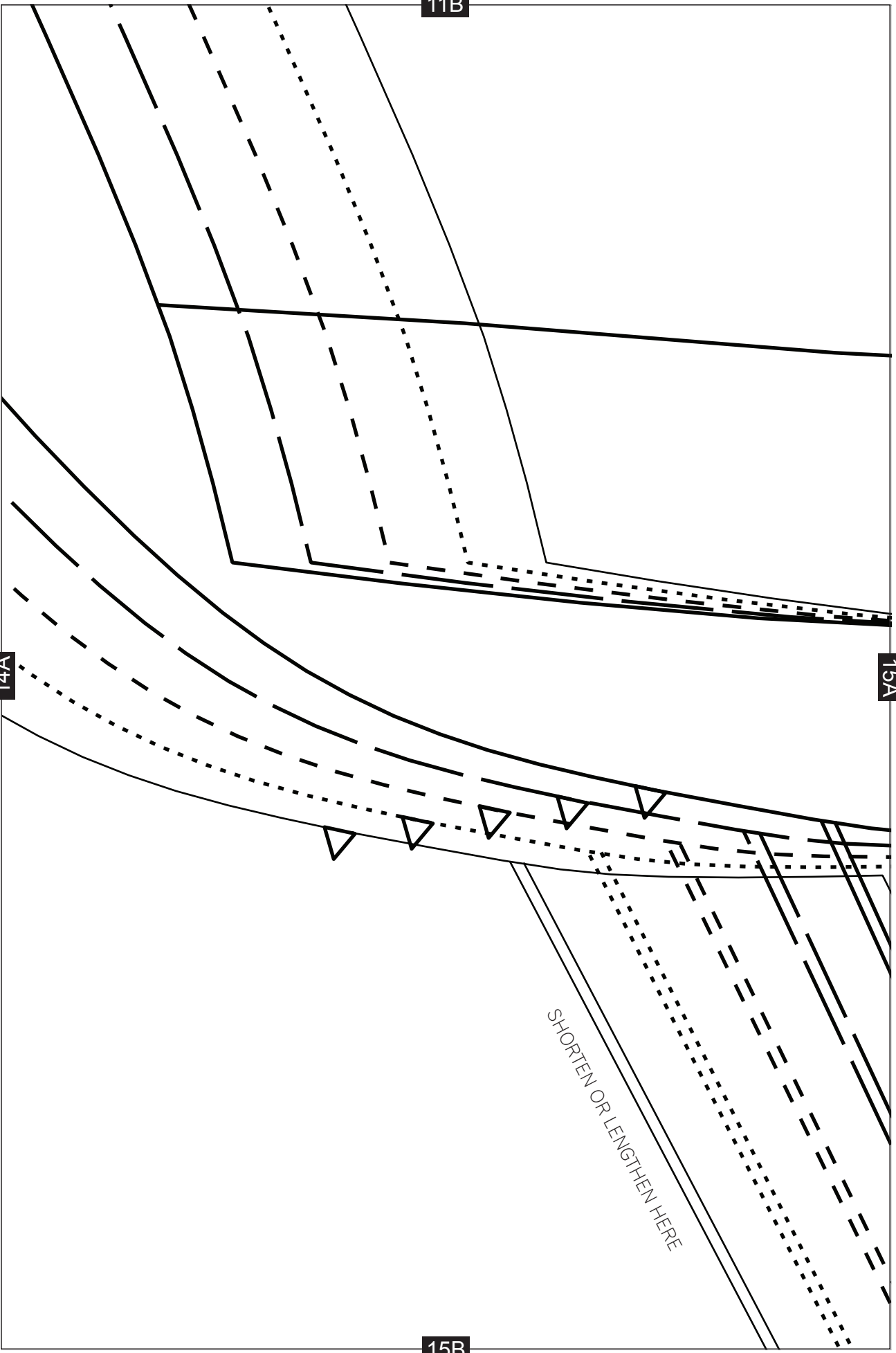

12B

CUT LINE FOR KIMONO JACKET (WOVEN)

CUT LINE FOR SLOUCHY CARDIGAN (JERSEY)

15A

16B

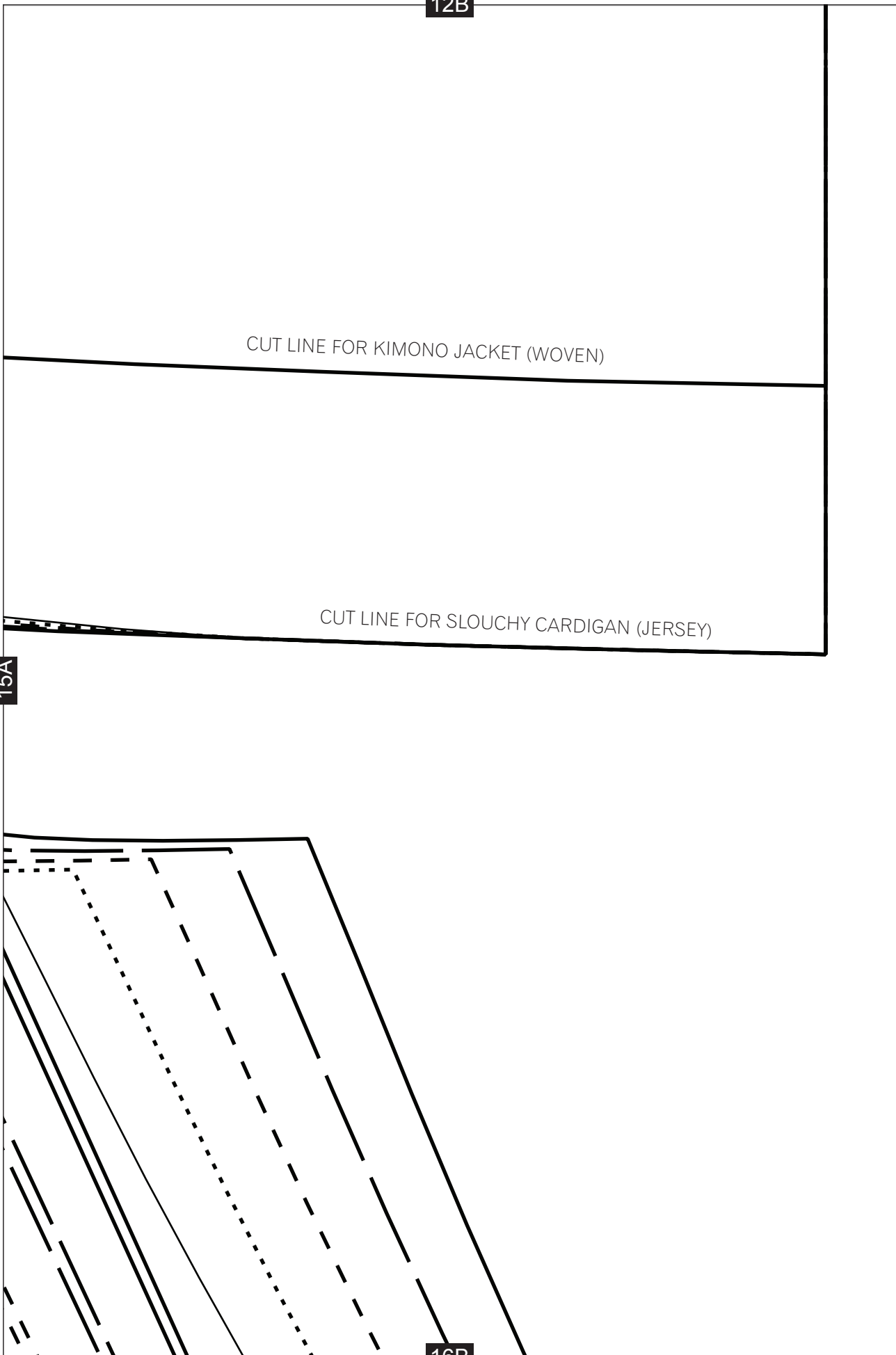

13B

CUT LINE FOR KIMONO JACKET (WOVEN)

17A

17B

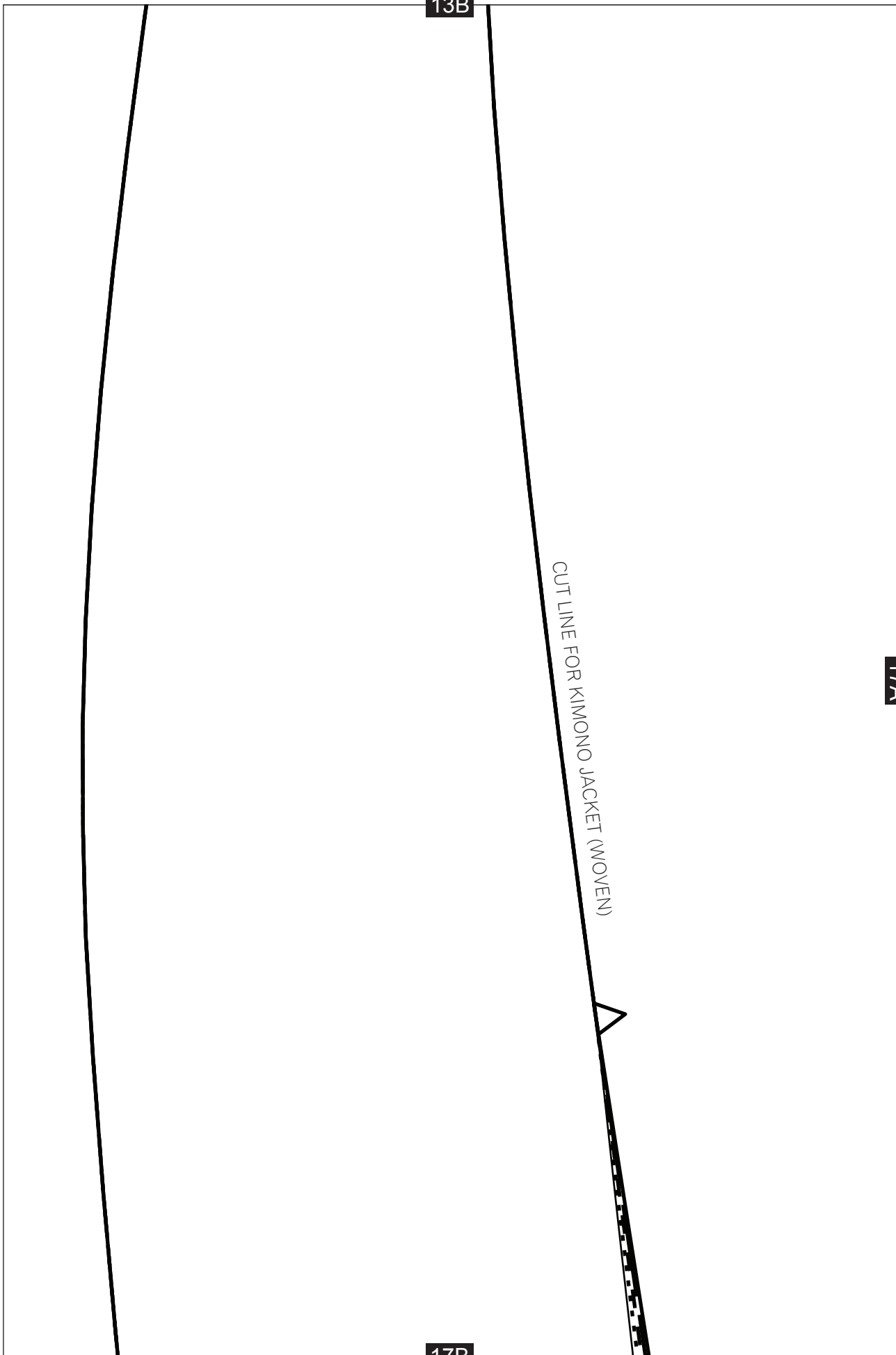

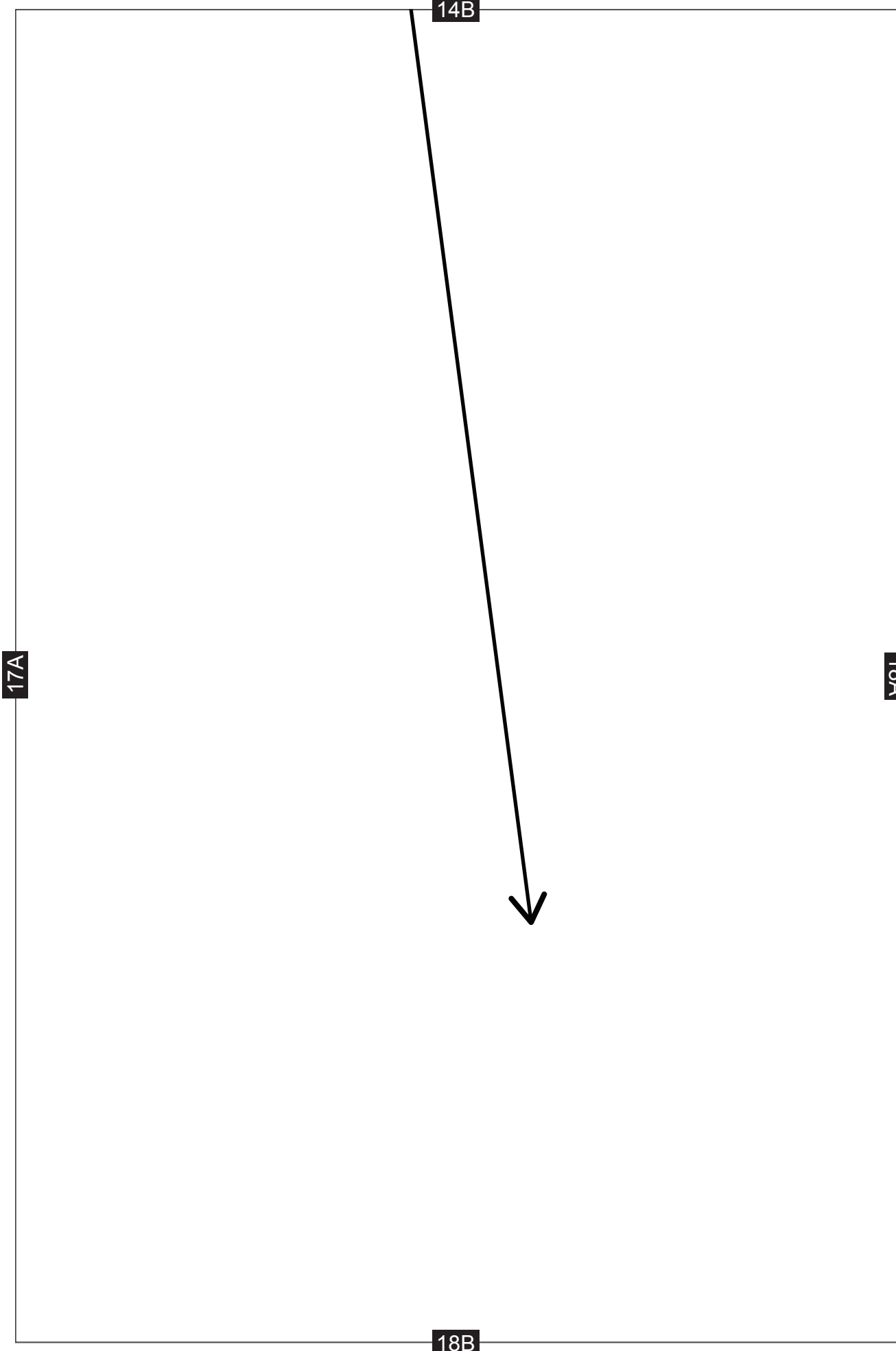

15B

THREE-HOUR SLOUCHY CARDIGAN

FRONT - CUT 2

18A

19A

19B

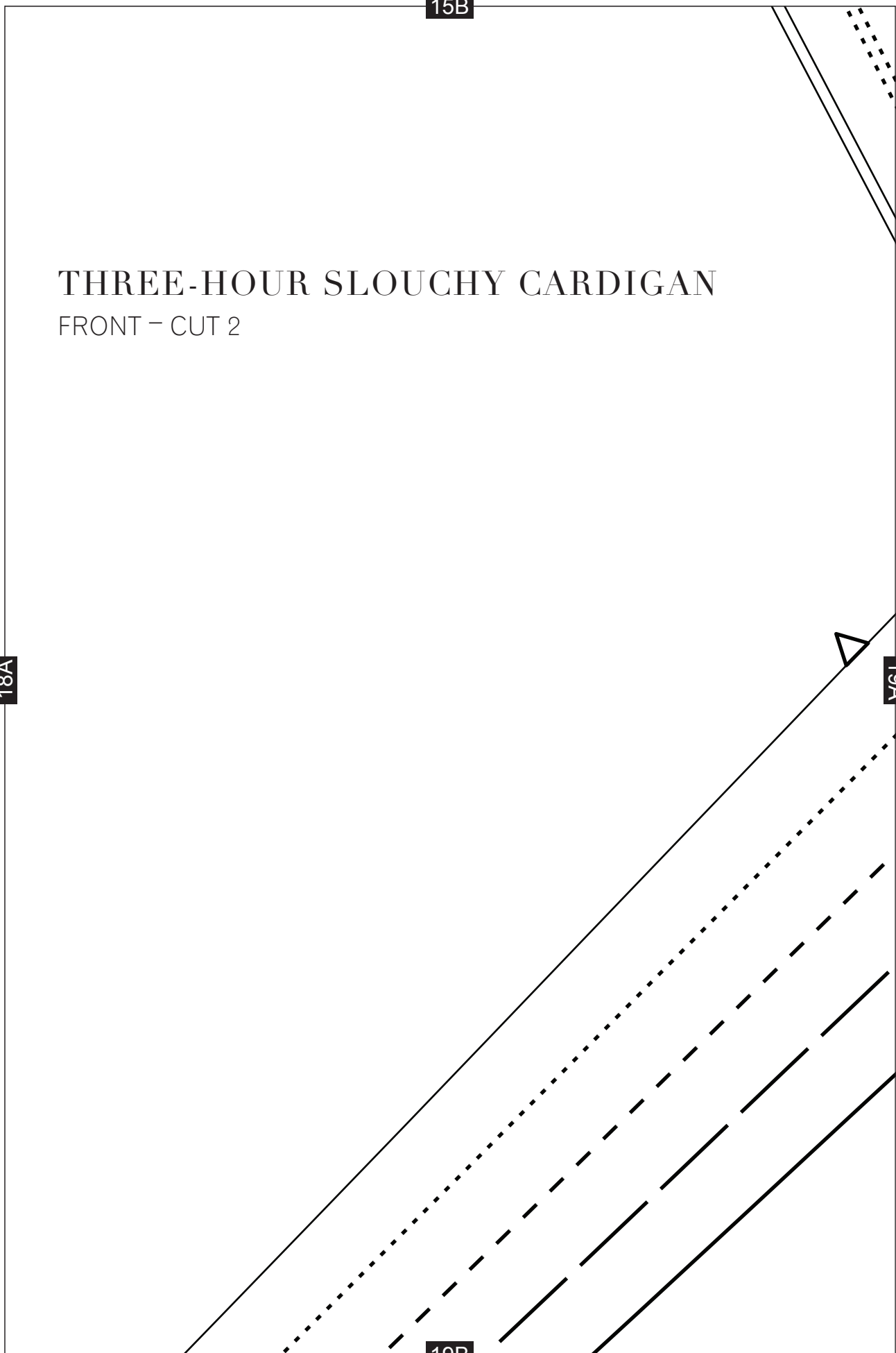

16B

19A

20B

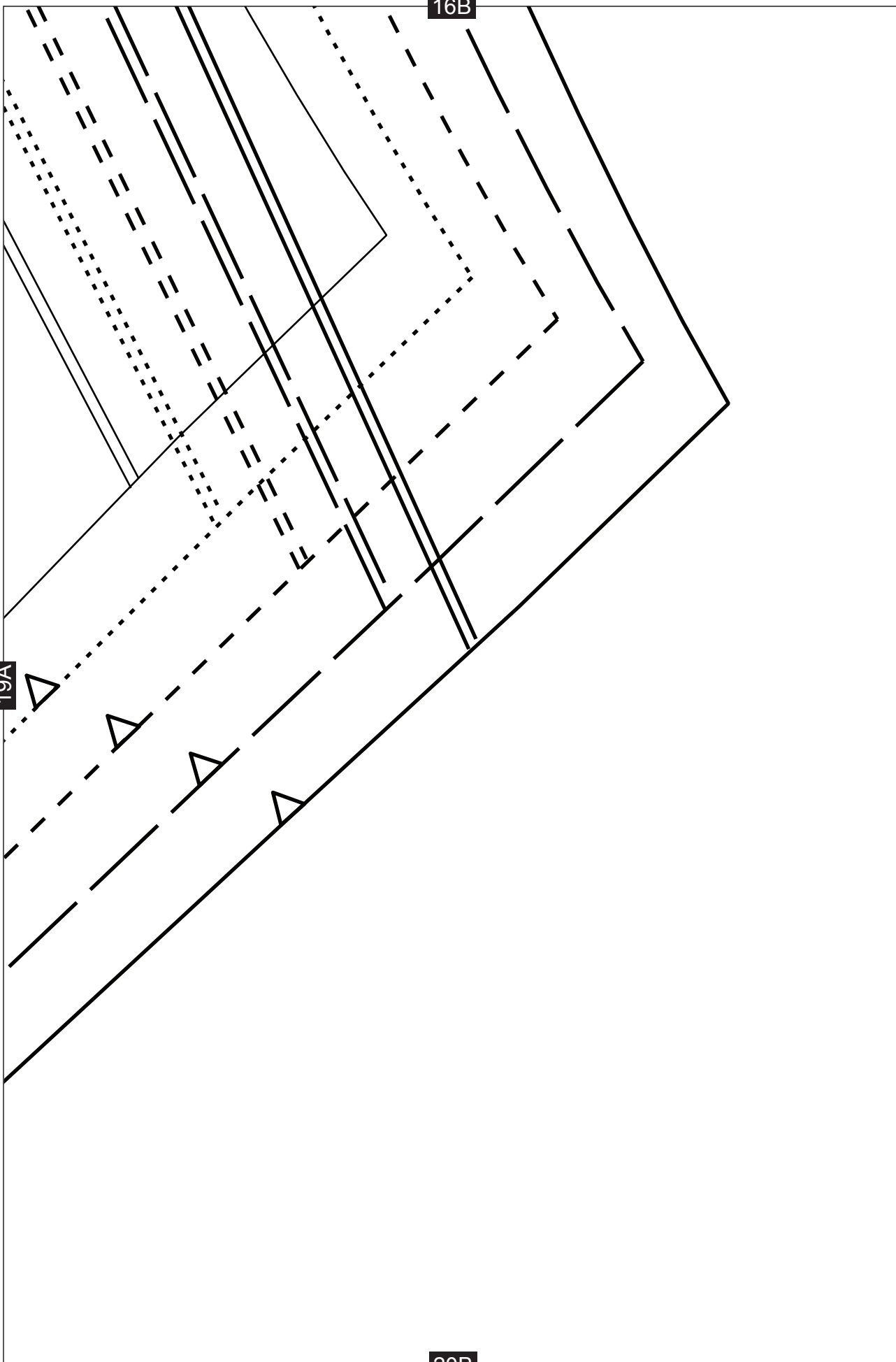

17B

21A

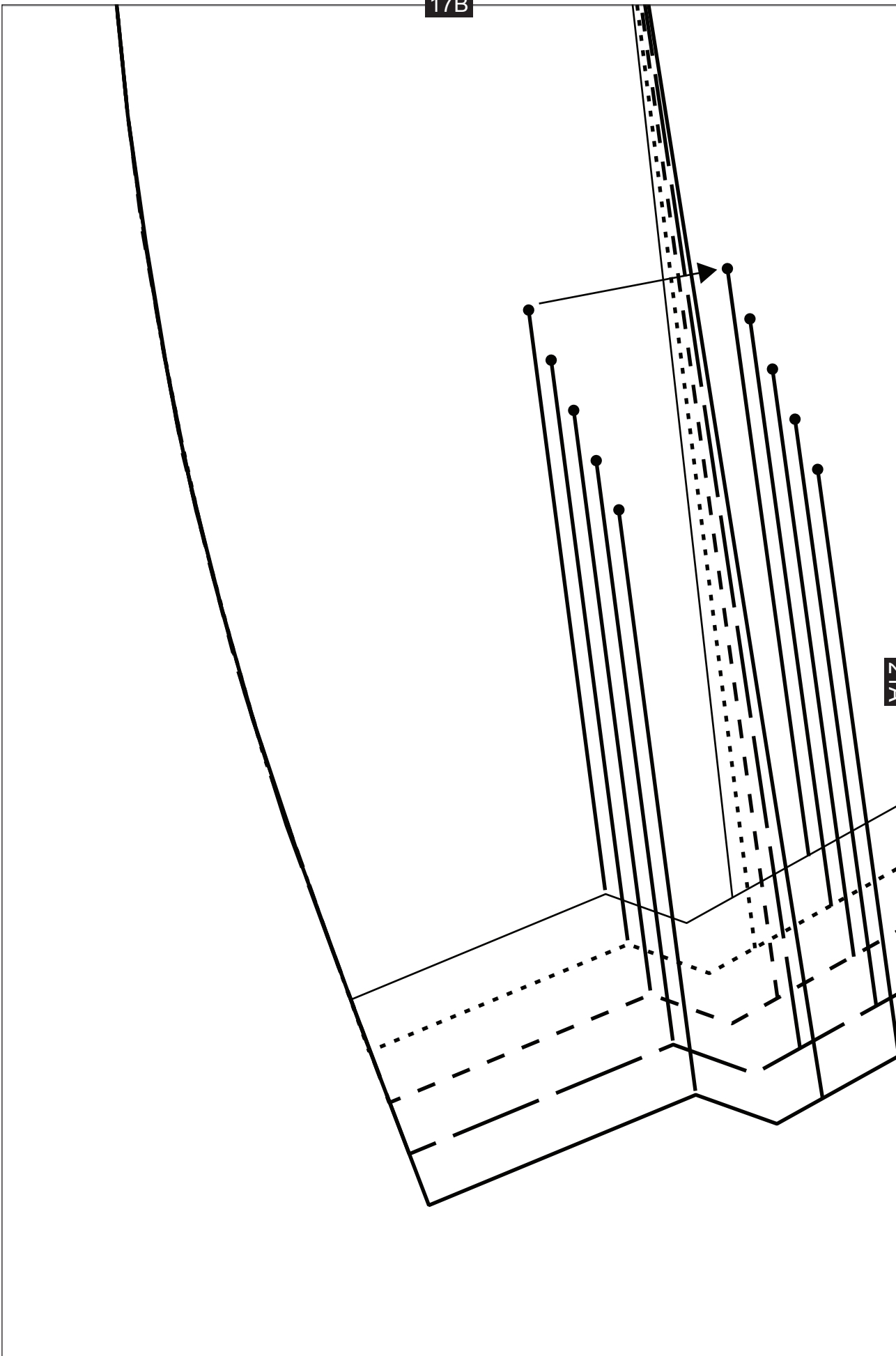

18B

21A

22A

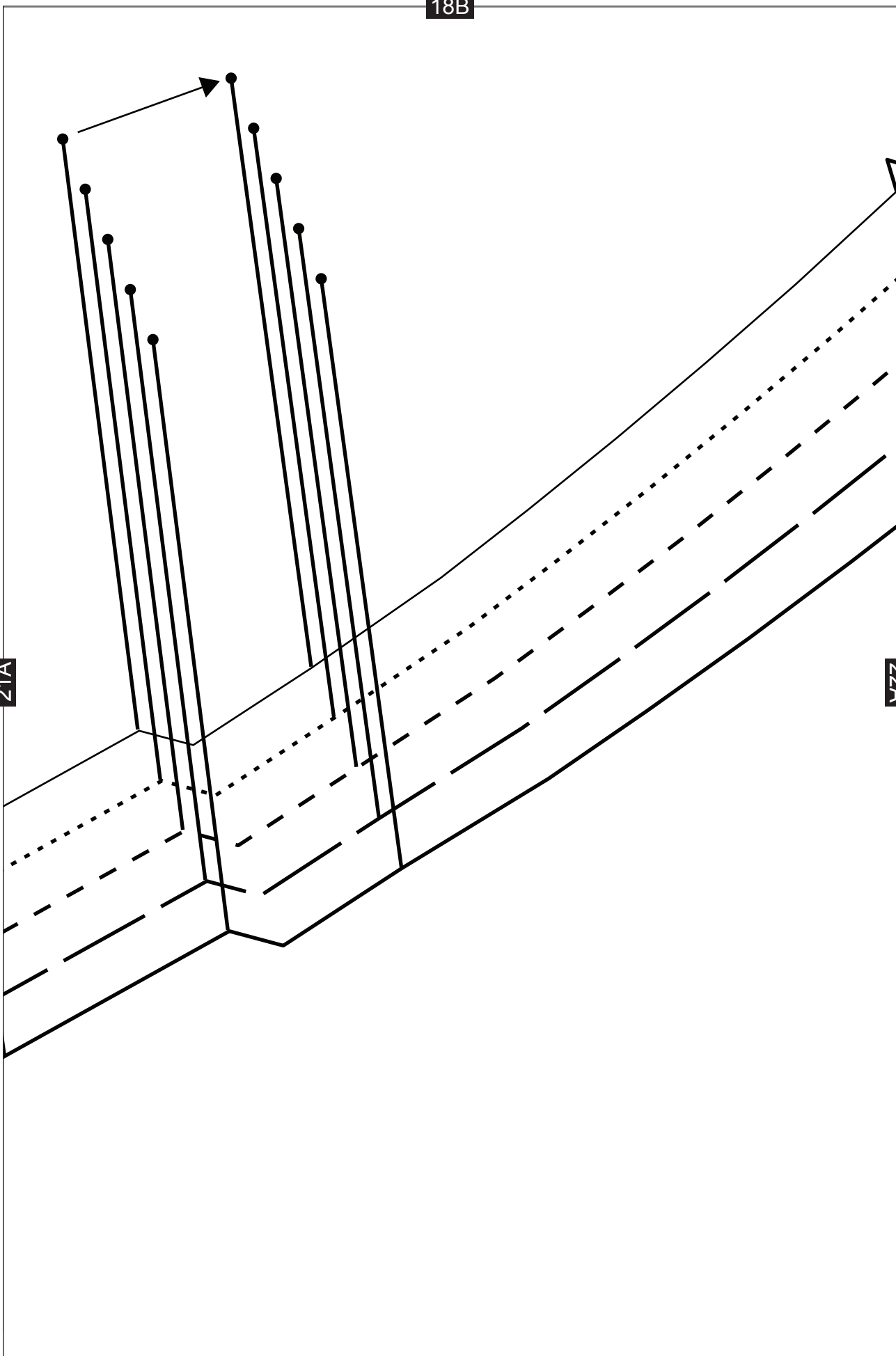

19B

22A

